



BASEMENT INSULATION

Minnesota Department of Commerce Energy Information Center

Homes with uninsulated basements can have one-third of their heat lost through the basement floor and walls. Since the earth around the basement is not a good insulator, the concrete itself conducts heat out of the house. This unnecessary heat loss could be costing \$150 or more each year. With a one-time cost of around \$600 for materials to insulate the foundation of a 1200-square-foot bungalow, your energy savings could pay for the cost of the project in four years. In addition, an insulated basement adds to your living space and will make your entire home more comfortable and evenly heated.

Interior and exterior insulating methods

Testing for moisture problems

Insulating a basement floor

Warning about leaky return air ducts

This guide describes two basic methods of insulating basements in existing homes. If you are building a new home or addition, follow the instructions for foundation insulation in our “New Homes” Home Energy Guide, available from our Energy Information Center.

You first need to decide whether to insulate the inside or the outside of the foundation walls, or whether insulating is a good idea at all (in cases of chronic moisture problems, adding insulation is not advised). See the Sidebars comparing the advantages and disadvantages of the interior and exterior methods. Review the pros and cons and decide on the better solution for you. This guide describes both methods, but insulating the interior is the most cost-effective for existing homes.

Before you start, familiarize yourself with the basic parts of a foundation wall (see Figure 3). The drawing shows a common construction technique referred to as platform framing, in which the floor joists sit atop a wood plate that in turn rests on the concrete foundation wall.

Interior basement insulation

Starting the job will be easier if the basement is completely unfinished, but chances are, some wall finishing work has been done. If there is no prop-

er air/vapor barrier and little or no insulation, it is best to remove the wall finishes and start over. This will allow you to check for moisture damage as well.

When insulating on the inside, it is recommended that an insulation value of R-13 to R-20 be added to the entire wall for greater energy saving and comfort. There are two ways to do this. The most common method uses wall framing filled with

Figure 1

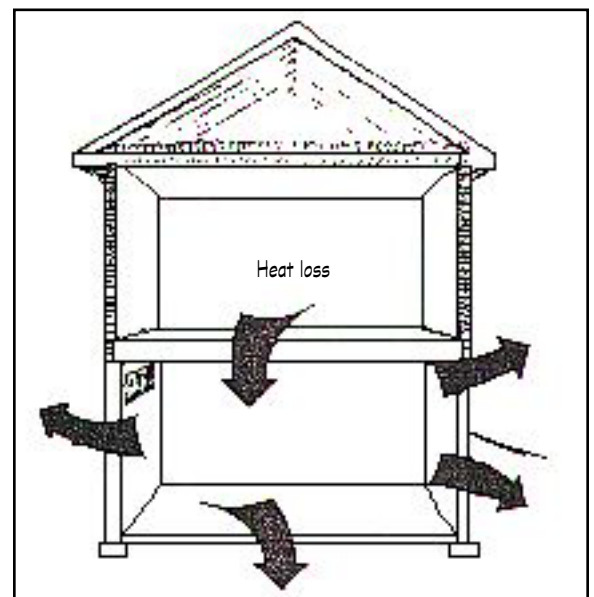

Related Guides:

Home Insulation

Home Moisture

Indoor Ventilation

What to do before you start

1. Before you insulate, read our *Combustion Air Home Energy Guide*, available from the Energy Information Center. It may not seem to make sense, but the more you seal up your house against outdoor air leaks the more you need to provide an outdoor air supply for your combustion appliances. Unless you have a sealed combustion furnace and water heater, you must have an outside air supply near your furnace and other fuel burning appliances. Having a dedicated combustion air supply provides the right amount of air in the right place, rather than relying on arbitrary air leaks throughout your house. This should be done before your basement is sealed and insulated. Our *Combustion Air* guide provides “how-to” instructions for installing a combustion air supply.
2. **WARNING: Seal air leaks in any return ducts.** Check to see that ducts or other cavities used as “returns” to your furnace are air tight. Research indicates that leaky returns cause uneven cooling in air conditioned homes and can create a potentially dangerous backdrafting problem with your gas furnace or water heater – possibly leading to elevated levels of carbon monoxide in the house.
3. **Check for water problems before insulating.** Don't attempt to cover up water problems with insulation and wall board. If moisture problems cannot be cured at the source, do not even consider insulating the interior of your basement. (See *Capillary Test Sidebar*.)
4. **Consult a local building official about codes and requirements.** If you are planning a basement bedroom, you are legally required to have egress windows, which are sized and located to serve as an easy escape route for occupants if needed. Also, visit your city hall or county permit office to obtain any necessary building or remodeling permits.

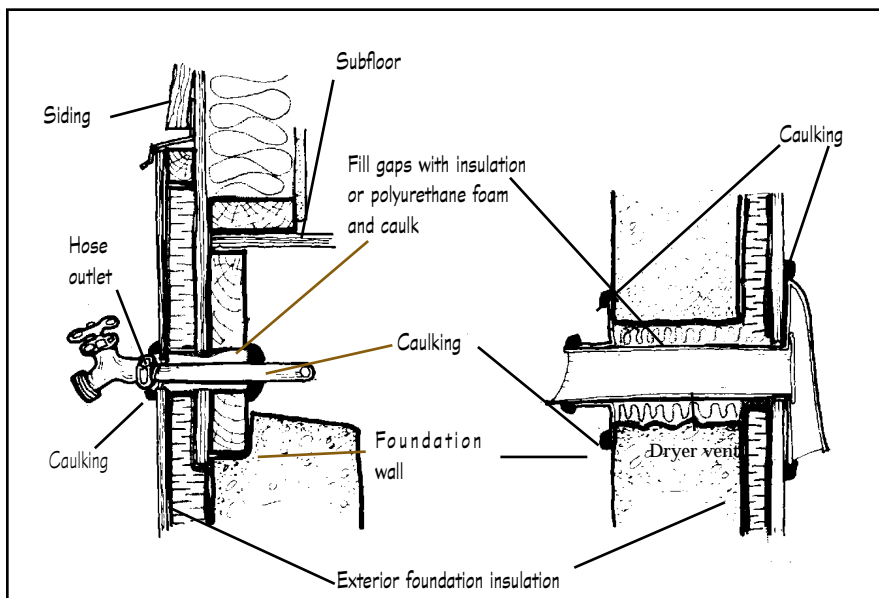

Figure 2
Use foam sealant for large gaps around penetrations in walls or joist areas.

fiberglass batts. This method is described in detail in this guide. The second method involves fastening extruded or expanded polystyrene or polyisocyanurate to the wall. A number of fastening systems can be used in addition to standard framing. Check the insulation manufacturer's literature for the recommended method of application.

Step 1: Seal the air leaks. It is easiest to seal the wall against air leakage before you start framing or applying rigid insulation. Locate and seal any air spaces around service pipes, ducts or conduits that go through the walls or end joists. This will not only stop air and moisture leakage, but will also help keep crawling and flying insects out. Use a good quality butyl or silicon caulk that is

compatible with concrete. Call the Energy Information Center for the *Caulking and Weatherstripping Home Energy Guide*, which explains types of caulking materials and methods of application. Where there are larger gaps, fill with foam backing rod or polyurethane spray foam (see Figure 2).

For comfort, cost and safety reasons, also make sure that the return air ducts or cavities that return air to your furnace are air tight. During the winter, warm indoor air causes the house to act like a big chimney, drawing air in at the lower parts of the house (slightly depressurizing the basement) and exhausting warm air through the upper levels wherever there is an opening in the wall or ceiling. Leaky returns add another avenue for air to flow out of the basement to the upper floors, strengthening the negative pressure in the basement. Ultimately, this pressure on air supply can cause backdrafting of the furnace and water heater – meaning the combustion gases that normally rise up the flue (including carbon monoxide) are drawn back into the house. Sealing the returns is an important step in avoiding this problem. In the summer, leaky returns allow cooled air to stay in the lower levels, completing a “short circuit” without reaching the upper floors. Difficulty in cooling the upper floors causes the air conditioner to run longer, resulting in high energy costs. Sealing the ducts with mastic or foil backed tape will allow better, more even air distribution and will help your air conditioner run

Figure 3: Interior insulation method

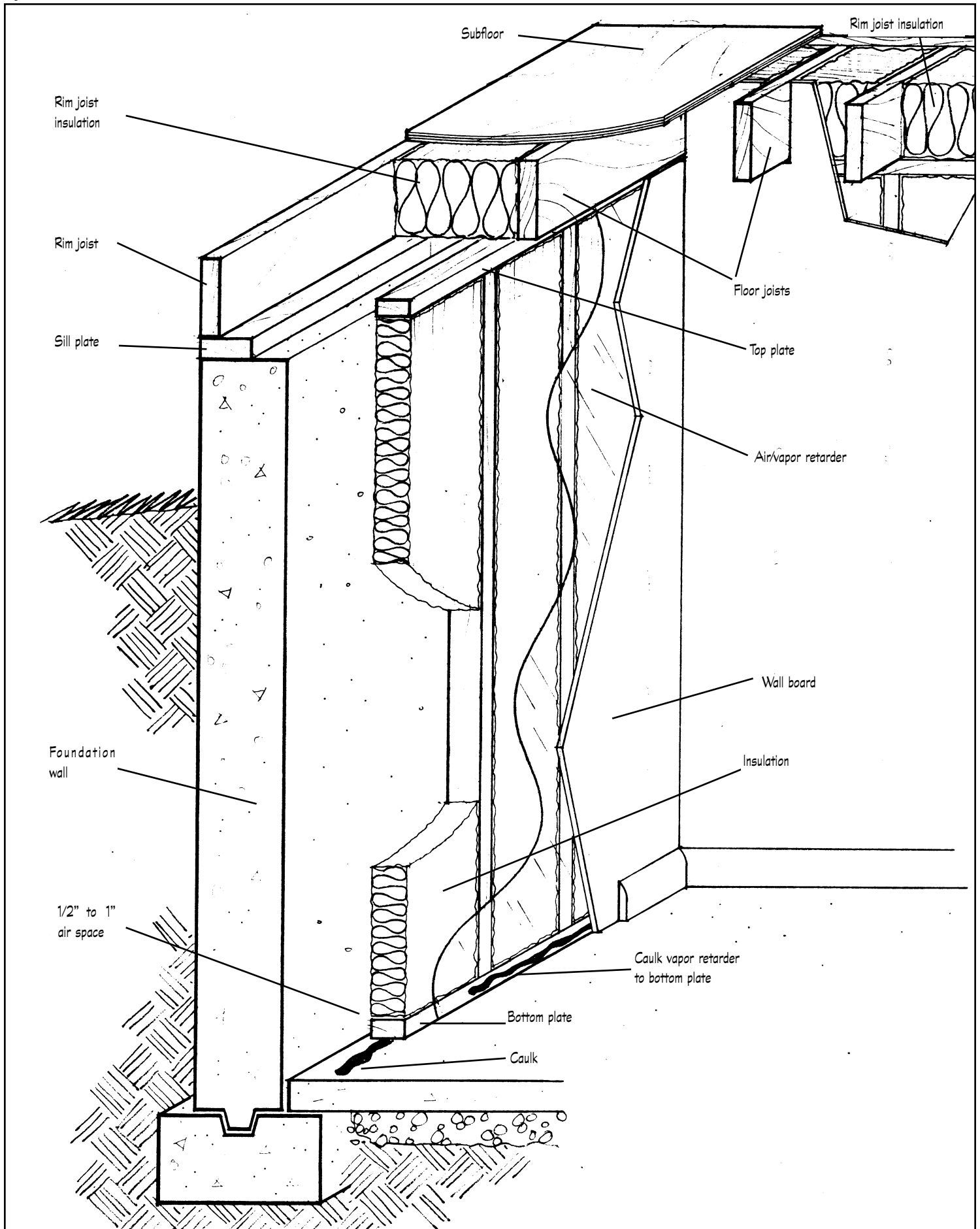

Tips

If you use a moisture barrier, make sure to extend it under the bottom plate.

Keep pipes and drains on the "warm" side of the insulation.

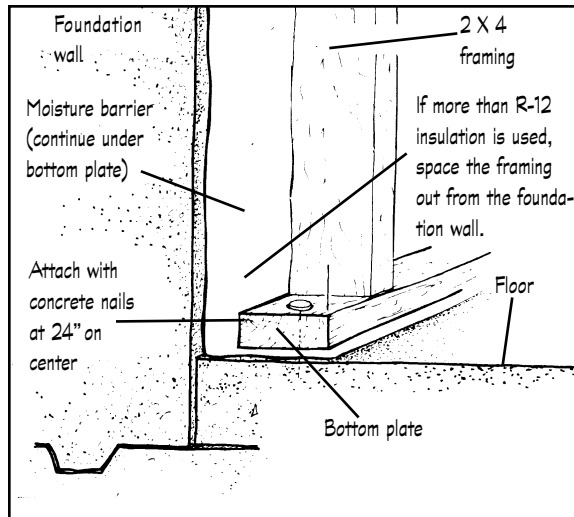

Figure 4

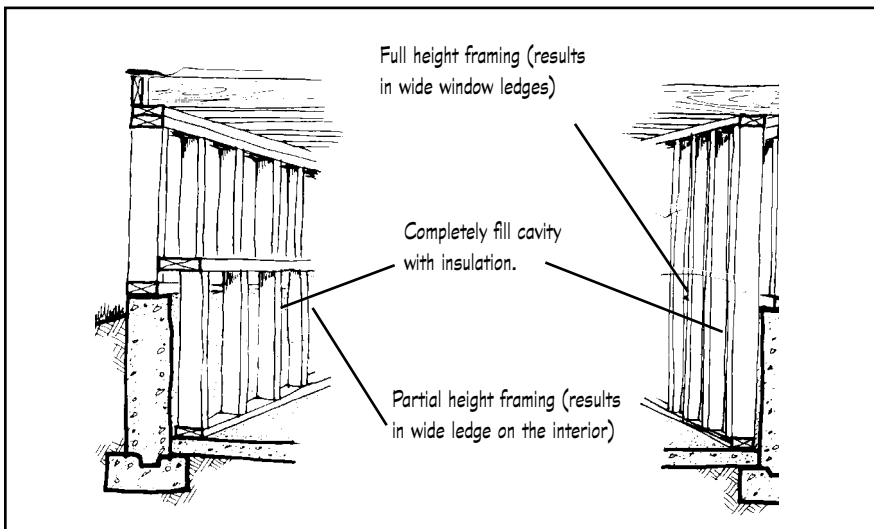

Figure 5
Two framing methods for a bi-level home.

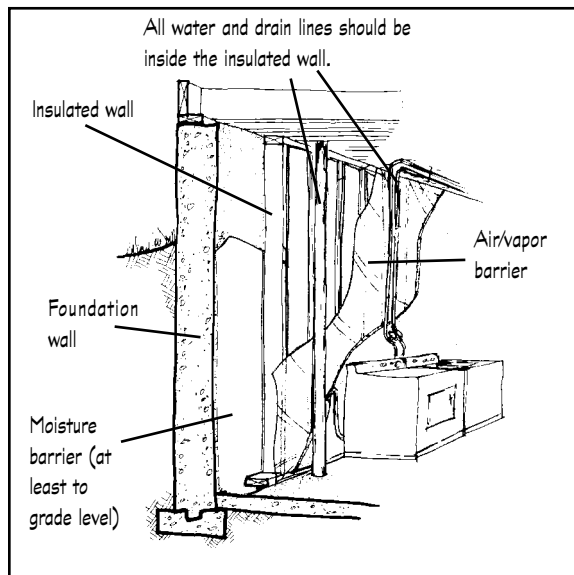

Figure 6

more efficiently. Do not use cloth backed "duct tape" on heating ducts because it will dry out and release over time.

Step 2: Consider installing a moisture barrier – but only if the foundation is dry. Moisture barriers are generally recommended, especially in new homes, to protect the insulation and framing materials from water damage. Also, homes over 10 years old often do not have drain tile at the footings, making the foundation walls and floor prone to moisture problems. If you are sure you have a dry basement, you may skip this step. If you are not sure, use the "Capillary Test" Sidebar to identify problem areas.

A moisture barrier (which functions differently than an air/vapor barrier, but can be the same material) is usually 6 mil polyethylene plastic attached to the bare foundation wall with an adhesive, a wooden batten, or stapled to the back side of the wall framing before the frame is placed against the wall. The moisture barrier can start at the top of the foundation wall or at ground level, but must extend down to the basement floor and under the bottom plate (see Figure 4). The goal is to keep outside moisture away from the insulation.

Step 3: Construct a wall frame. Use wall framing of 2 x 4s at 24 inches on center to provide an insulation cavity, wiring space and support for the interior finish. The interior face of the wall frame can be placed 3 - 1/2 inches from the foundation wall for R-13 batt insulation or 5 - 1/2 inches for R-21 batts. If the foundation wall is uneven, the frame can stand out from the wall. A common technique is to use 2 x 6 plates with 2 x 4 studs, which allows extra space for an uneven wall. An additional one-half to one-inch air space between the frame and the wall is recommended if you are not using a moisture barrier. Use a single top and bottom plate and single members around windows. Always use treated lumber for the bottom plate, and for the stud wall as well if you plan to finish the basement.

Bi-level homes are a special case. Two techniques for framing a bi-level are shown in Figure 5. Framing around stair wells and landings may also pose problems. Another exception is a cold storage room, which does not require framing or

insulation on the outside walls, but interior walls need to be insulated from the rest of the basement. Crawlspace also need to be sealed and insulated properly to avoid basement moisture problems. (Follow the procedure for insulating crawlspaces in the Home Insulation Home Energy Guide.)

Each situation is unique and you may have to improvise. If possible, place the framing behind any pipes or ducts located close to the foundation wall to prevent freezing (see Figure 6). Never leave pipes or drains on the outside, or “cold” side of the insulation layer. Thinner pieces of rigid insulation may be used behind pipes or lines where framing won’t fit.

Many plumbing reference books outline simple drainage and water line renovations, if moving them is necessary. Moving electrical panels or gas and water meters requires qualified professionals and may be expensive. Electric panels are still “live” even when the main switch is off. The simplest solution is often to just insulate and frame as closely as possible to the unit. Remember to cover all insulation with drywall.

Step 4: Seal only large holes in the rim joist. Research indicates that over 25 percent of a typical home’s air leakage occurs in the rim joist area. While this is clearly too much leakage, some of this air may be needed by your appliances. Reducing air leakage in the lower part of your home without providing sufficient air for combustion and exhaust appliances increases the risk of carbon monoxide exposure in your home. Sealing the rim joist should be considered only when there is a sealed combustion heating system and a sealed combustion water heater. Other fuel burning appliances using wood, propane and fuel oil also need to have a sealed combustion design if you plan to seal the rim joist. These include space heaters, room heaters, gas fireplaces and fireplace inserts.

Over-sealing the rim joist may reduce the air leakage in your home to the point of creating an unhealthy environment; yet, homes with moisture problems may need the rim joist sealed to prevent damage to the building. In that case, a mechanical ventilation system may be needed for acceptable indoor air quality and relief of excess

moisture. Our Home Moisture Home Energy Guide will help you solve moisture problems at their source.

In bi-level homes, treat the lower level like a basement, even though it is largely above grade. Seal only the large holes in the rim joist area. On upper levels, regardless of house style, the band joist area should be well sealed.

Homes with all electric heating and water heating appliances may have the rim joist sealed without increased risk of carbon monoxide exposure; but they may need a mechanical ventilation system for moisture control and acceptable indoor air quality.

Cantilevered rim joists are another exception to the rule and can usually be sealed without compromising your safety. A simple method is to cut pieces of sheetrock or plasterboard to fit each joist space (the area between the joists, the floor above and the sill plate below.) Then, caulk all the seams to stop water vapor and air leakage.

Step 5: Install insulation on walls (and joist space, if appropriate.) Fiberglass batt insulation is usually used because it is relatively inexpensive and easy to install in vertical spaces. Place insulation in the wall cavities formed by the framing. The stud spaces must be completely filled to prevent air movement behind the insulation, which can result in increased heat loss. Make sure to cut the insulation pieces to exact sizes required. Do not fold or overlap pieces to make them fit.

Insulate the “warm side” of the walls separating a cold storage room from the heated basement. The ceiling of a cold storage room must also be insu-

Figure 7

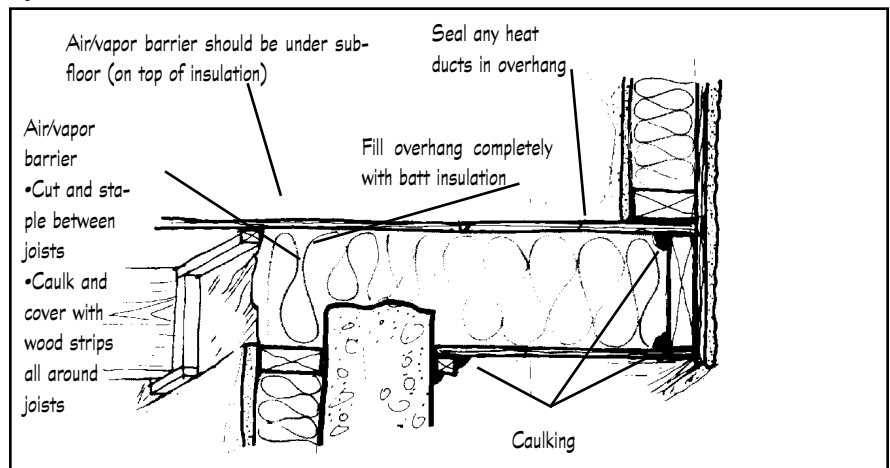

Tools for the job

Safety and protection equipment such as a hard hat, goggles, gloves and a breathing mask should be used when working with power tools and insulation materials.

Interior method

- Basic carpentry tools
- Sharp knife for cutting insulation batts, rigid insulation, and air/vapor barriers
- Caulking gun, stapler
- Drill, masonry bit and masonry nails

Exterior method

- Shovels, pick and wheelbarrow
- Scraper and stiff brush for cleaning the exposed foundation wall
- Short bristle paint brush for applying water-proofing material
- Basic carpentry tools
- Drill, concrete bit, masonry nails or anchors if attachment to concrete is required

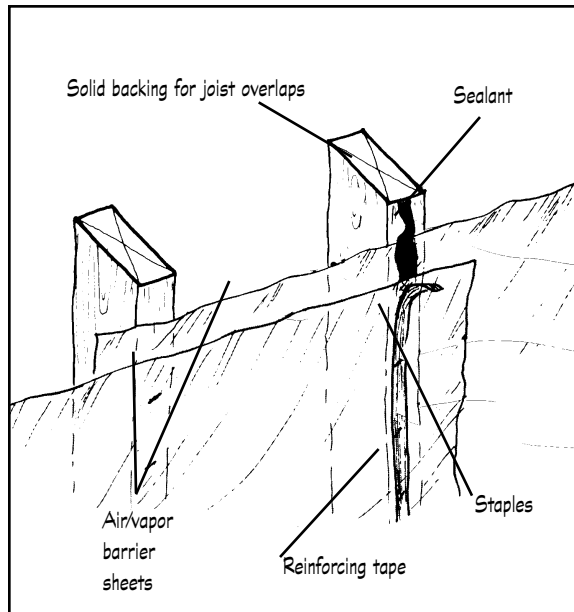

Figure 8
Overlap the air/vapor barrier at least one joist or stud space. (Insulation is not shown.)

lated in order to warm the floor above. If your home has bow windows or bi-level construction, seal the floor overhangs well and insulate as shown in Figure 7.

Before proceeding, check the insulation you have installed to make sure all areas have been filled and make sure no pipes or ducts have been covered by the insulation.

Step 6: Apply the air/vapor barrier. Also called an air/vapor “retarder,” it is essential to add this layer of protection on the inner or “warm” side of the insulation. This barrier can be provided by 4 or 6 mil polyethylene. Staple the polyethylene to the framing, using only enough staples to hold the material in place. Do not pull it tight. All seams should overlap one joist or stud space (see Figure 8). Better contractors use acoustical sealant (a caulk and glue mixture) to seal the barrier against air leakage. Overlaps, joints or edges can be reinforced with a strong tape (do not use cloth backed duct tape) before stapling. The barrier should also be sealed around windows and exterior door openings as shown in Figure 9.

It is important to create as complete an air/vapor barrier as possible between the inside and outside. Make sure you do not accidentally puncture the barrier. Repair any tears or holes in the polyethylene before covering with plaster or drywall.

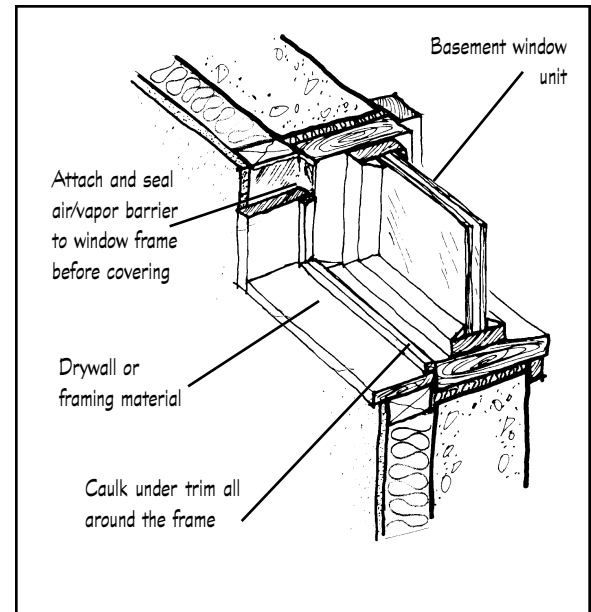

Figure 9
Seal around window and door openings.

Moisture problems: Symptoms and solutions

Moisture problems may or may not be obvious. Fungus and mildew on the cement block, or cracked and bulging foundation walls are sure signs of moisture. Feel the surface of the wall and look for a powder-like “efflorescence” on the wall, indicating the remains of excess moisture. If the basement is finished, you might see brown water marks on the sheetrock or paneling, or rust on the bottom of the furnace or boiler. You can test for moisture by following the “Capillary Test.”

Moisture problems must be solved at their source before you insulate your basement. The first place to look is outside, around the foundation (see Figure 10). Are your rain gutters and downspouts cleaned out and positioned to keep water away from the foundation? Downspouts should lead water at least 10 feet away from the house. Also, make sure the ground slopes away from the foundation (even if you have to add a truckload of dirt around the perimeter of your house) and make sure that sidewalks, driveways or a neighbor’s downspouts are not directing run-off toward your house. If exterior control methods are ineffective, you may need to hire a contractor to install drain tile at the foundation footings. In that case, you may want to insulate the exterior rather than the interior.

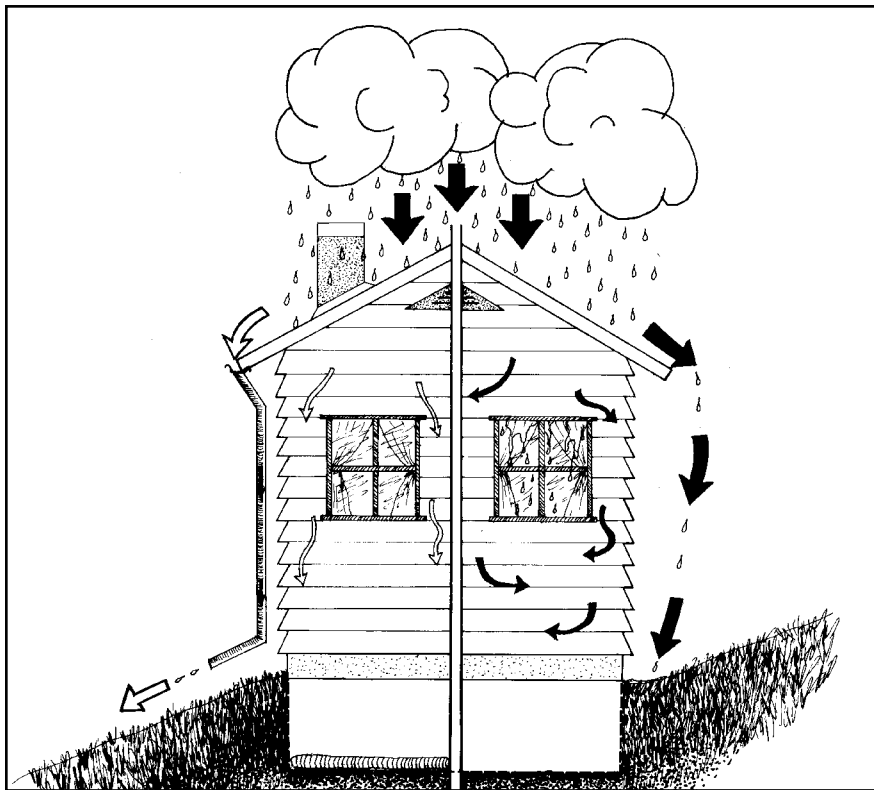

Figure 10
Gutters, a slope away from the house, and drainage tile in the foundation keep the left side of this house dry. No gutters, a slope toward the house, and no drainage tile expose the right side to moisture damage.

Waterproof paint, by itself, is not an effective remedy against moisture problems. After resolving outside sources of the problem, then you can benefit from applying waterproof paint before insulating and finishing the inside.

Exterior basement insulation

Insulating a basement from the outside may be the logical choice for newer homes where the landscaping is not completed, or if the exterior foundation wall needs repair. General directions for installing exterior insulation are described here, but you should always consult the insulation manufacturer's literature for specific installation techniques.

Insulating the exterior involves digging around your foundation. In all cases, before you begin you must mark the location and depth of utility services such as electrical lines, gas pipes, as well as telephone and cable TV hook-ups. In Minnesota you can call one number to check the location of all utility lines on your property. Call Gopher State One at 651-454-0002 in the Twin Cities metro area, or from Greater Minnesota, call toll-free 1-800-252-1166.

The most practical way for the do-it-yourselfer to insulate the exterior is the "apron" method, as shown in Figure 11. This is a partial depth method, where insulation is placed against the wall to extend 12 inches below ground and a second piece is placed horizontally to extend about two feet out from the bottom of the vertical piece. Above ground, it is best if the insulation extends high enough to cover the rim joists, but since it is often difficult to remove existing siding, you can place the insulation up to the bottom edge of the siding, then insulate the rim joist area from the inside. This method will effectively reduce most of the heat loss from your foundation.

Insulating down the entire wall to the footings is another method, but it is difficult and probably not cost-effective unless you have to dig down for another reason, such as adding drain tile. This method requires a professional building contractor.

Step 1: Prepare the wall. Begin by digging a trench about 18 inches deep around the foundation. Clean the newly exposed wall area of dirt or other debris with a brush or scraper. If the black damp-proofing is dry, cracked or missing, repair

Capillary Test

To determine if moisture is coming through the foundation walls or floor to the inside, or whether moisture is coming from inside the house itself, do the following simple test:

1. Identify the damp interior or surface. Testing multiple locations on the floor and walls may be necessary to locate external sources of moisture.
2. Dry a portion of the damp area, at least 2' by 2', using a hair dryer. (Testing larger 10' areas is suggested.)
3. Cover the dried area with an air/vapor barrier, preferably polyethylene, firmly attached and sealed with tape around the edges.
 4. Check the underside of the barrier after a couple of days.
 - If there are beads of moisture under the plastic, there is water seeping or wicking into the house.
 - If the plastic is wet on the room side and dry underneath, the dampness is from an inside source of moisture.
 - If both sides are damp, it indicates both external and internal condensation problems.
 5. Leave the plastic in place for up to two months to test the basement under a variety of conditions.
 6. Consult a professional if the test is hard to interpret. Seasonal variations in water flow patterns and the ground water table can lead to confusing results.

Tip

Because insulating the exterior is more expensive and difficult than insulating on the inside, it is probably a cost-effective option only if you have to dig around the foundation for other reasons, such as making repairs, adding drainage or solving an exterior moisture problem.

– Energy Information Center

the affected area. Building supply stores carry bituminous coatings for this purpose that can be brushed on by the homeowner. Be sure to follow the manufacturer's instructions carefully and allow any new damp-proof coatings to dry completely before applying insulation.

Inspect all wall penetrations and surface mounted fixtures such as exterior taps, exhaust vents, electrical outlets, hose bibs and gas lines. These should be sealed to the foundation wall with a waterproof putty, grout or silicone sealant. If possible, extend fixtures out from the wall to accommodate the insulation. Hire a qualified contractor to move gas or electrical fixtures.

Step 2: Install flashing. Loosen the lower edge of the siding or stucco and building paper. Leave the siding pulled away about one-fourth inch from the wall so that a flashing (also called drip cap or J-channel) can be installed beneath it. The flashing allows the insulation to extend beyond the line of the siding or stucco and protects the insulation and foundation from rain. The flashing should be wide enough to cover the thickness of both the insulation and protective covering.

Slide the flashing into place under the existing siding or stucco and building paper before you install the wall insulation. There are many details necessary for a good installation. Refer to a good general construction or remodeling manual (check your public library) for details appropriate for your home.

Step 3: Install wall insulation. There is a variety of materials that can be used for exterior insulation. Common materials include: extruded and expanded polystyrene, foil-faced polyisocyanurate, and rigid fiberglass. High density expanded polystyrene can also be used and is the least expensive, but is not reported to perform as well as the other three options. Before using a low-density type, such as beadboard, verify the suitability of the product for underground use. Materials not tested and approved are known to decompose underground. Extruded polystyrene can be used underground both vertically and horizontally, as needed for the apron method. Rigid fiberglass and polyisocyanurate can only be used vertically against the wall, not for the horizontal apron piece. Whatever product you choose, plan to insulate to a minimum of R-10.

The recommended method for applying and fastening insulation to basement walls depends on the type and thickness of the insulation and the soil conditions. If a product is sold for below-grade use, the manufacturer must provide information on methods of application.

If the backfill is heavy clay, or other non-porous soil, attach a "ledge" of pressure treated lumber to the foundation wall at the bottom of the vertical insulation to help keep the insulation board in place.

Step 4: Install a protective wall covering. The insulation must be protected to avoid physical damage from lawn mowers or garden tools. In addition, all rigid insulation materials must be protected from direct exposure to sunlight. A number of materials can provide this protective covering: exterior grade plywood, stucco, cement, brick or treated siding.

Stucco or siding is often used because it is easy to color these materials to match your home. Stucco can be applied over a wire lath which can be attached directly to the rigid insulation. Wear hand and eye protection when working with wire. (Some new stucco products do not require the use of a wire lath.) Check with the product manufacturer for exact wall preparation requirements.

Siding material such as exterior grade plywood can be applied over rigid insulation with a variety of fasteners. The protective coating should reach at least 9 inches below ground level.

Step 5: Backfill. When the siding, insulation and flashing are all in place you can back fill with soil. You may have to add extra soil around the foundation to achieve a sufficient slope away from the house. A 1-inch drop for every 18 inches of travel is recommended to ensure proper run-off of rain water. Make a point to talk to your contractor about being careful not to damage the insulation while backfilling.

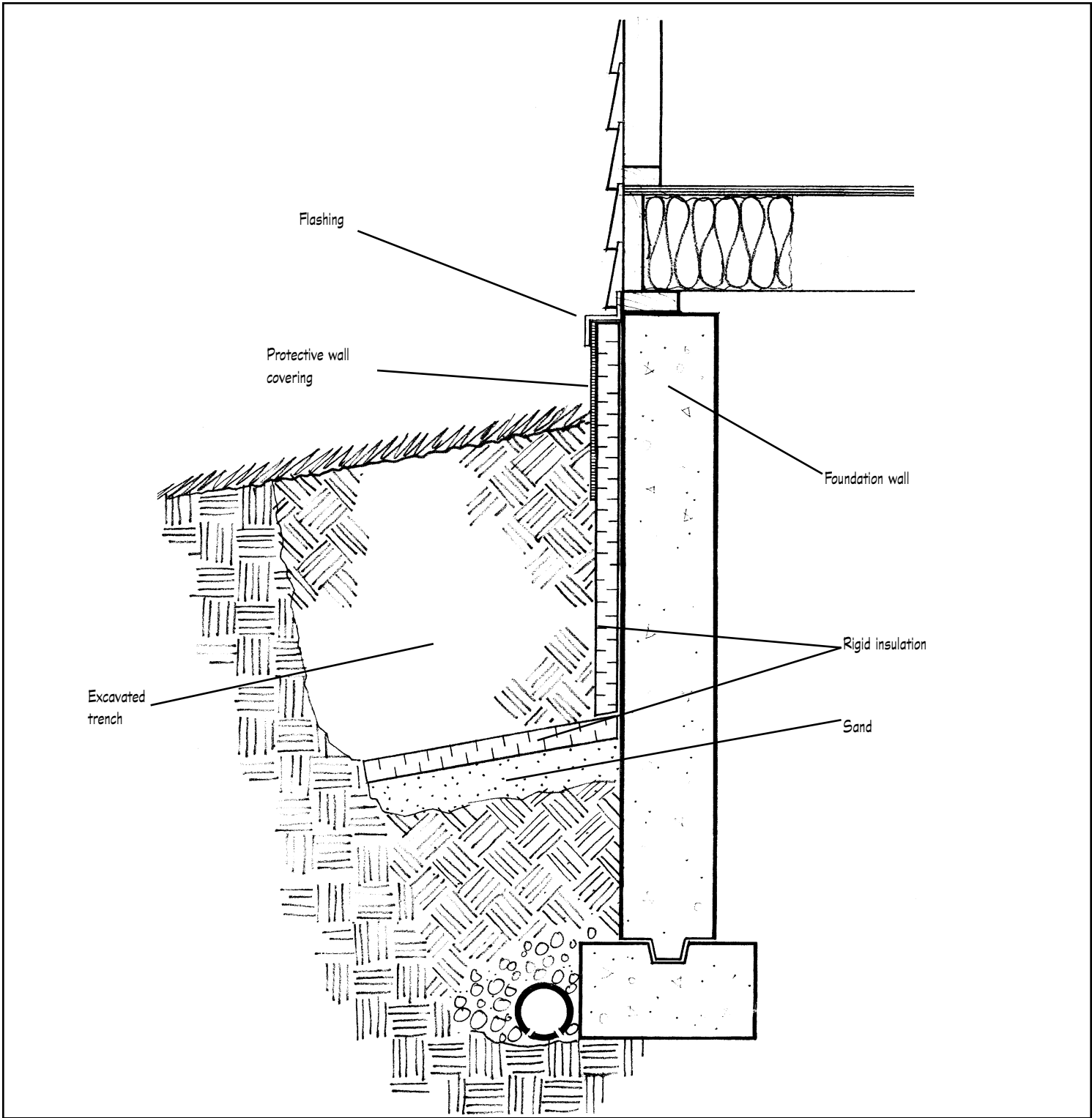

Figure 11
Exterior "Apron" method

Should I Insulate Basement Floor on Inside?

Interior advantages

- Results in a level wall surface for easy finishing
- Work can be done in any weather
- Wiring and plumbing space provided
- Good air/vapor barrier can be installed
- No disturbance of landscaping
- Adds to your living space
- Can be an on-going project (although, don't leave insulation exposed for any length of time. It must be covered with flame retardant drywall as soon as possible after installation.)

Interior disadvantages

- Existing interior finishing may have to be removed
- Difficult if many ducts and pipes are against the wall
- Insulation must be behind water lines to avoid freezing
- Loss of usable living space during construction period.
- Must install egress windows if you are adding a sleeping room in the basement

Insulating the basement floor

Although basement floor insulation is hard to justify from an energy savings point of view, it can increase the comfort level considerably. Simply installing carpet over the cement slab will provide a minimum level of thermal comfort, but is also vulnerable to mold and mildew. A more effective method is to build a "sleeper floor," using similar steps and materials used to insulate interior basement walls. (See Figure 12.)

A word of caution: make sure that your basement is dry before insulating the floor. Check for moisture by doing the "capillary test" described in the Sidebar. If a damp spot occurs within 24 hours of

applying the test sheet of polyethylene, the floor is too moist. Do not insulate until the moisture problem is corrected. Also, avoid insulating the floor in areas where shifting or swelling soil might lift the basement floor.

To insulate a concrete floor, first place a polyethylene moisture barrier on the concrete to prevent the transfer of moisture to the sub-floor. Frame and insulate the sub-floor with batts or rigid board insulation, following a similar process as when insulating an interior foundation wall. Apply an air/vapor barrier, then install plywood sheeting or other sub-floor material, and finish with your choice of floor covering.

Figure 12
Building a sleeper floor helps assure warmth and comfort.

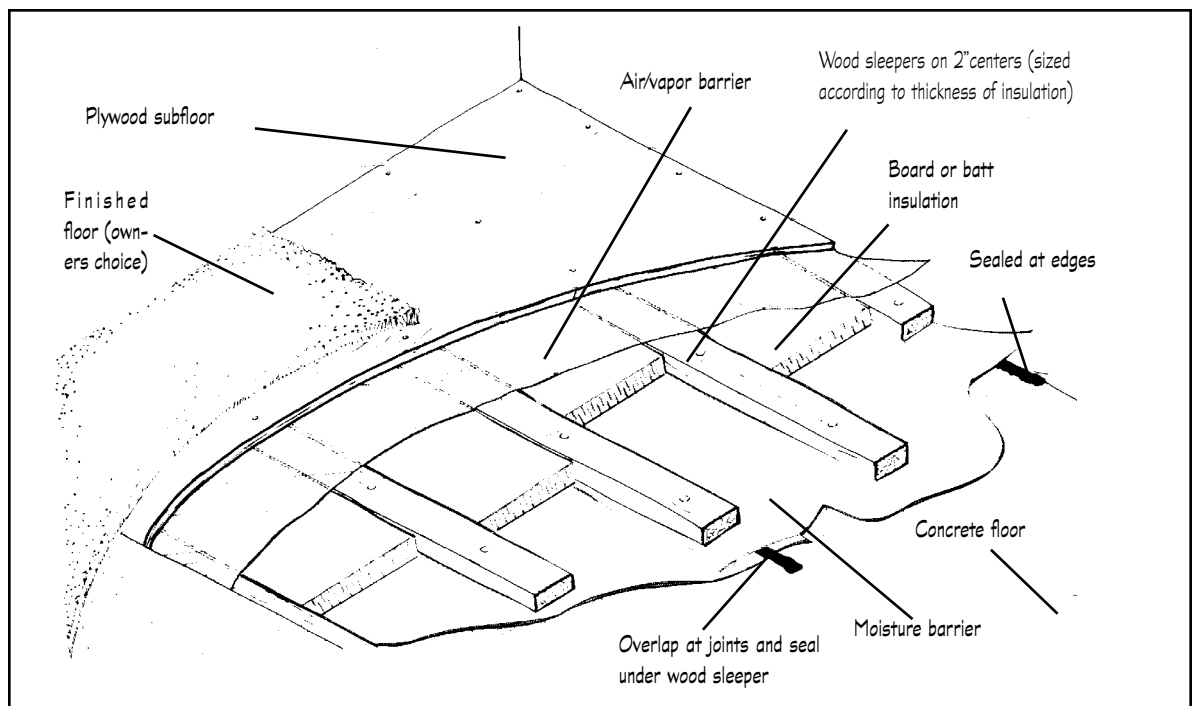

Summary of insulation methods

Before you start:

- Make sure you have a combustion air supply for your gas or oil furnace, boiler and water heater. Sealing and insulating your basement can have a major effect on the fresh air supply needed by all fuel burning appliances. Call the Energy Information Center for the Combustion Air Home Energy Guide.
- Seal any leaks in the duct work that carries return air to the furnace. Leaky ducts can cause your furnace or water heater to backdraft dangerous combustion gases.
- Evaluate moisture conditions in the basement. Do not install interior insulation until moisture problems are corrected.
- Check your gutters, downspouts and landscaping around the foundation to make sure rain water is properly draining away from your house.
- Choose between exterior or interior basement insulation. Then decide on materials to use, including existing materials that can be salvaged.
- Measure your requirements and obtain cost estimates from suppliers or contractors. Ask to see manufacturer's literature on the insulation you purchase.
- Check on low-interest loans that may be available for home energy improvements. Call the Energy Information Center to find out about current funding sources.

- Obtain permits from your city officials before remodeling your house or its electrical system.

For the interior method:

- Seal air leaks in walls and some joist areas. (Don't over-seal the rim joist area.)
- Apply a moisture barrier only if the basement is dry.
- Frame the wall and make any required electrical, plumbing or heating changes.
- Apply insulation to the wall.
- Apply air/vapor barrier.
- Finish walls, ceilings and window casings.
- Install egress windows in areas intended for sleeping.

For the exterior method:

- Excavate around the foundation and clean the wall of dirt and debris.
- Loosen siding or stucco to install flashing.
- Insulate wall by selected method.
- Apply a protective covering to the insulation and backfill excavation carefully.
- Nail down siding and flashing.

Should I Insulate Basement Floor on Outside?

Exterior advantages

- No disturbance of previous interior work
- Interior water lines protected
- No loss of living space during the project
- Any cracks or leaks in the foundation can be repaired
- Certain insulating materials will act as an additional moisture barrier, depending on application
- A good option if indoor moisture problems prohibit interior insulation

Exterior disadvantages

- Requires extensive digging which can be physically demanding
- May be difficult or impossible to do near patios, steps, or deck
- Disturbs existing landscaping
- Must be completed quickly to avoid flooding if it rains
- Must be completed in warm weather
- Generally uses more expensive materials
- Not advisable in extreme southern Minnesota because of termites
- Protective coating is subject to damage